

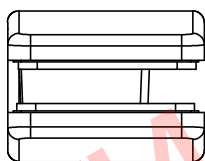

Contro Serratura per LO  
LO Lock Keeper

www.vetroricambi.it

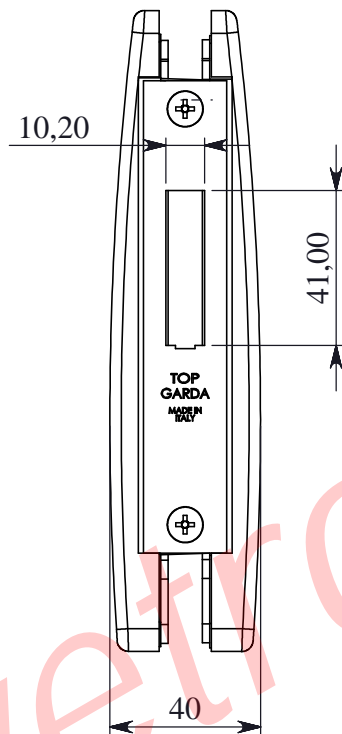
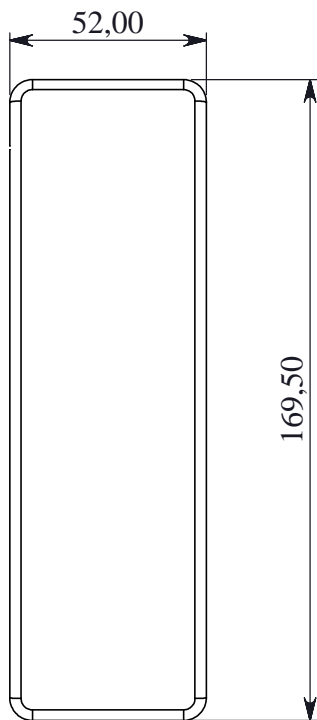

Vetro: 10-12 mm

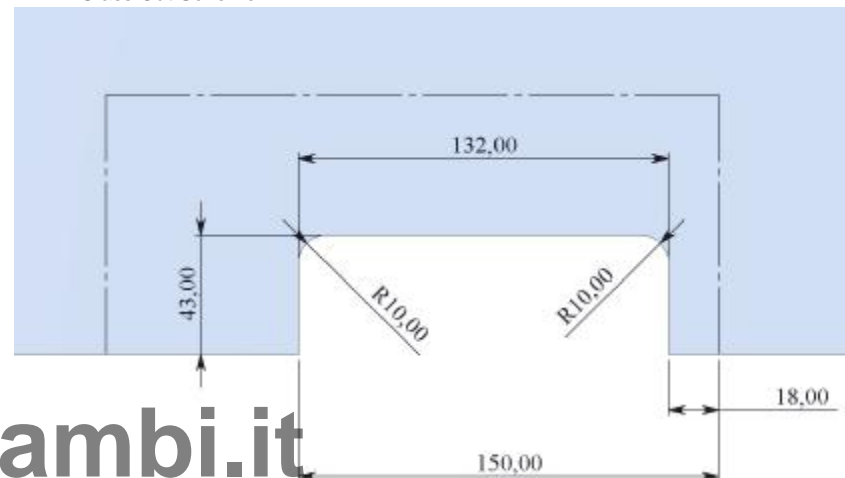

Glass: 10-12mm

Schema per Taglio Vetro  
Glass Cut Scheme



Finiture Superficiali Disponibili  
Available Surface Finishing

-  1. Acciaio Inox LUCIDATO
-  2. Rivestimento PVD oro
-  3. Acciaio Inox SATINATO

-  1. POUISHED Stainless Steel
-  2. Gold PVD coating
-  3. SATIN Stainless Steel



www.vetroricambi.it